



Seeding technology

Aress • Orbit • KSE • Seedstar



REGENT – A STRONG BRAND

TECHNOLOGY OF POWER HARROWS AND SEEDING BY REGENT

For more than 90 years Regent has been developing, producing and distributing innovative technology for soil cultivation and seeding technology rooted in its home site in Attnang-Puchheim. Our targets: increase the productivity of our customers, reduce operating costs and steadily improve the profitability of our machines.

Our goals:

- Increasing the productivity of our customers
- Reducing operating costs
- Constantly improving the profitability of our machines

Our motivation is cross-generational passion – a must is transparency and an easy adjustment of our machines. Closely connected with farmers of today and tomorrow we are always focused on the customer.

Your advantages:

- Experience in the technology of power harrows and seeding for more than 20 years
- Easy and comfortable use
- Robust construction for a long service life
- Effective and powerful
- Easy moving and fuel-efficient

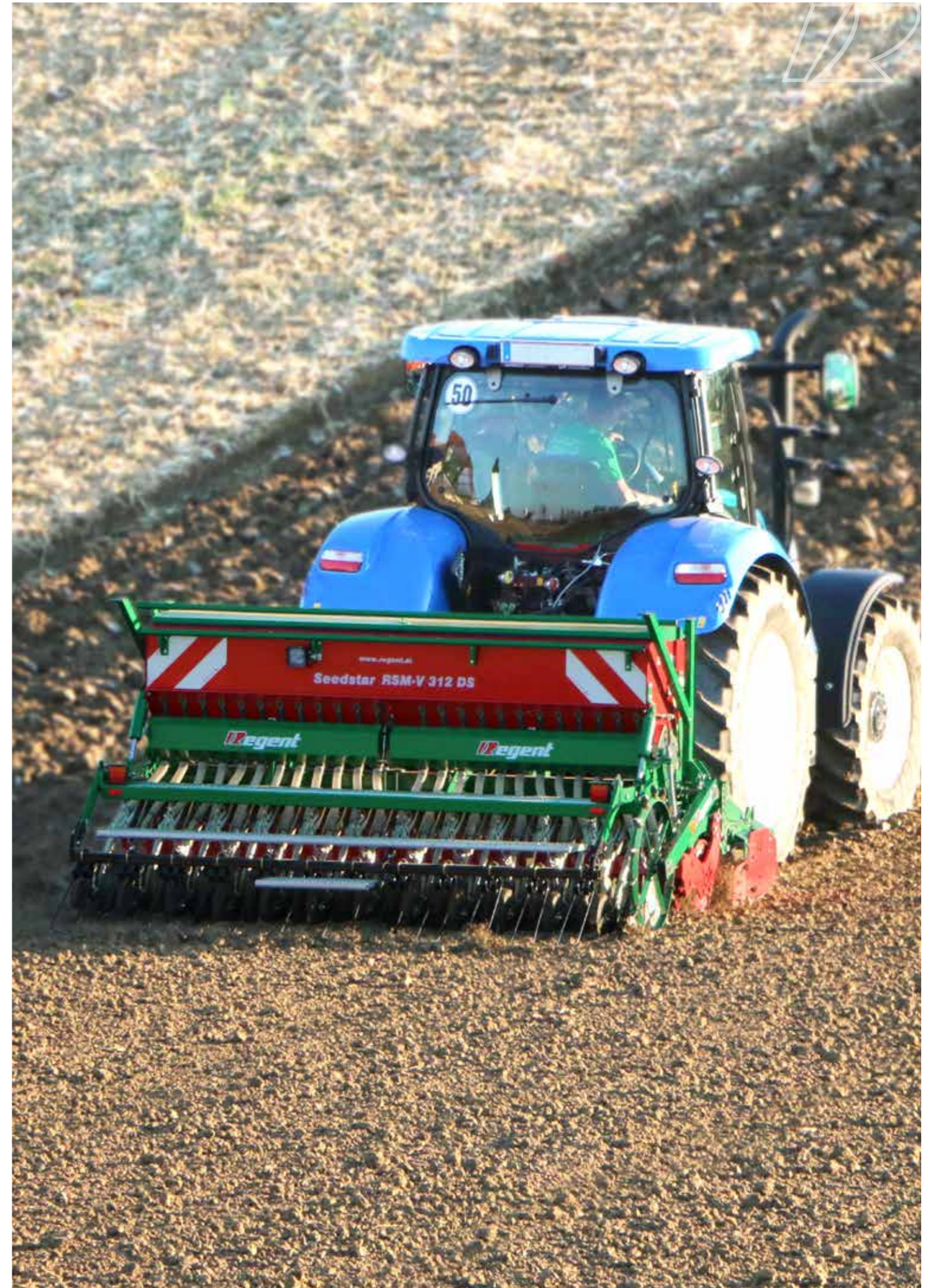

Aress

small power requirement at optimal working quality

The Aress power harrow models have a frame pipe, which is upstream of the tank and so the deformation stability is increased enormously. Furthermore the tank is protected from damages by this frame pipe. The power harrows are very easy moving. Outstandingly suitable for tractors up to 95 kW (130 HP) max.

As standard all models have:

- A frame pipe which is upstream of the tank
- P.t.o. through drive
- Change gear
- Drive wheels in oil bath
- Levelling bar in the back adjustable infinitely
- Foldable side boards, height-adjustable
- Lower lifting arms cat. II, adjustable
- P.t.o. shaft with friction clutch
- Tine dimension 15x300 mm

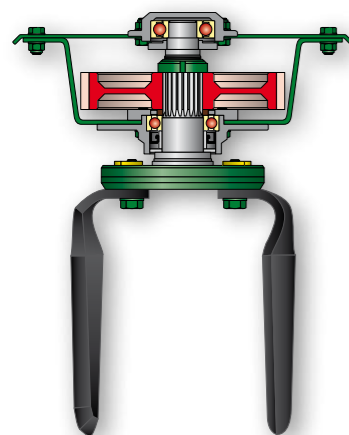
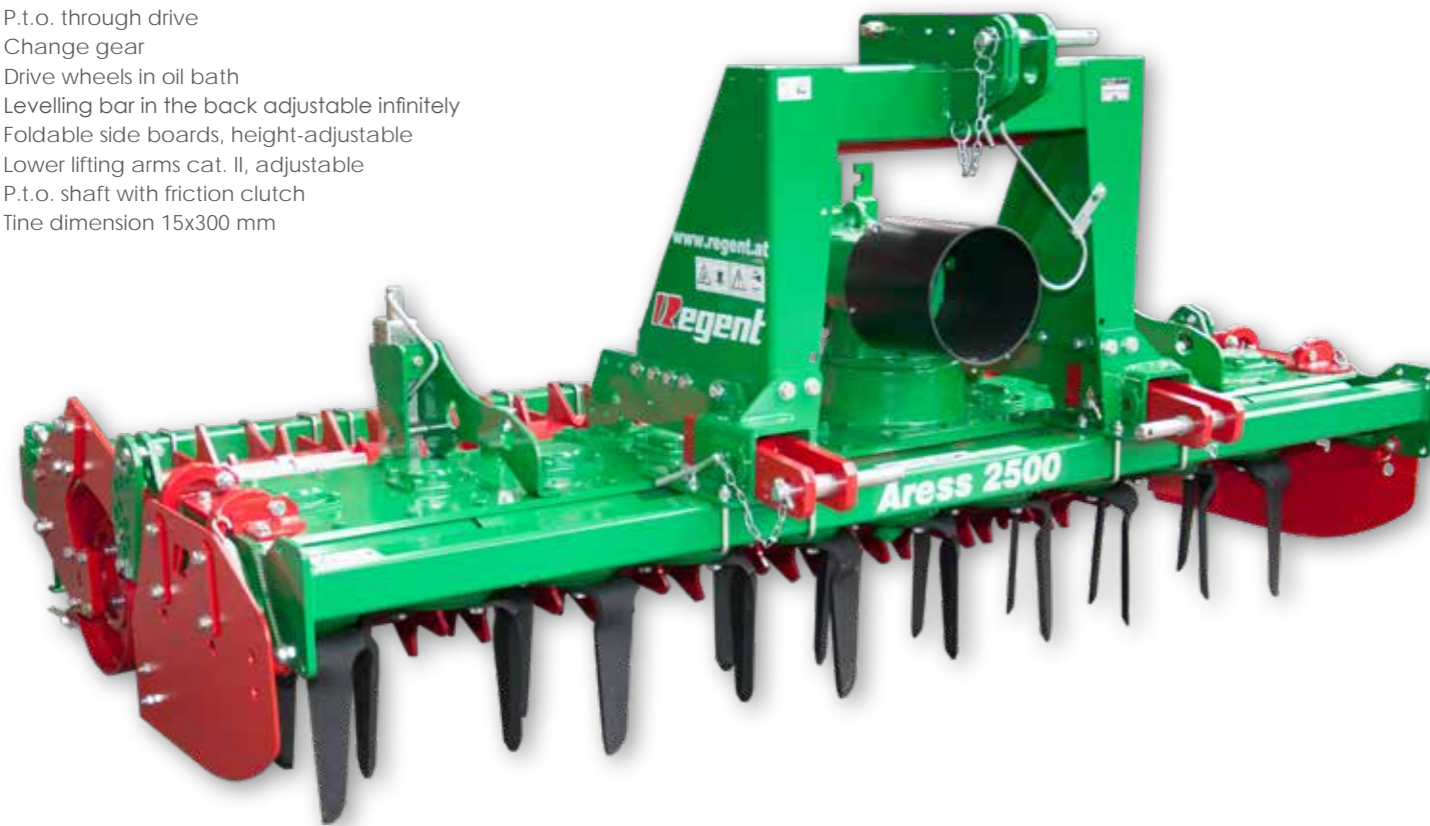

Bearing

- Big distances of bearing are due to a solid bearing of the rotors
- Stable bearing by screwed bearing carrier (easy to service)
- Conical tooth system between gear wheels and rotor shafts
- Circular knife carrier (stone rejecting)
- Protection from foreign parts by additional cover disc
- Ball bearing
- Tub strength 5 mm

Orbit

Power harrows with exceeding technique for highest demands

The generation of power harrows Orbit provides an optimal mixing and crumbling of the soil for the seedbed preparation on ploughed or unploughed areas. This series stand out for its high robustness and is very well suited for tractors to 180 KW (250 HP) max.

As standard all models have:

- Headstock with lateral supports
- A frame pipe which is upstream the tank
- P.t.o. shaft entry shifted backwards with longer drive shaft for a low angulation
- P.t.o. through drive
- Change gear drive (2nd gear set included in scope of delivery)
- Levelling bar in the back adjustable infinitely
- Foldable Side boards, height-adjustable
- Lower lifting arms cat. II, adjustable
- P.t.o. shaft with friction clutch
- Dimension tines: 15 x 300 at mod: M
15 x 330 at mod: S

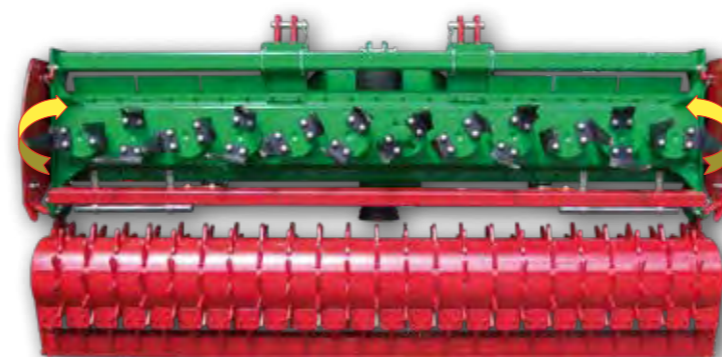

Operation

The easy moving of these models is due to the phase adjustment of the blades and the amount of the rotors.

- Good mixing up and crumbling of the soil
- Working without vibration
- Very smooth running

Bearing

- Big dimensioned taper roller bearing
- Front section toothing of the gear wheels
- Curved form of the toothed wheel (high absorption of axial loads)
- Single bearing housing
- The fixing of the blades works by a double nut plate (easy to service)
- Circular knife carrier (stone rejecting)
- Hardened rotors and blades holder
- Labyrinth glands with support rings
- Tub strength: 6+6 mm at mod.: M
8+8 mm at mod.: S

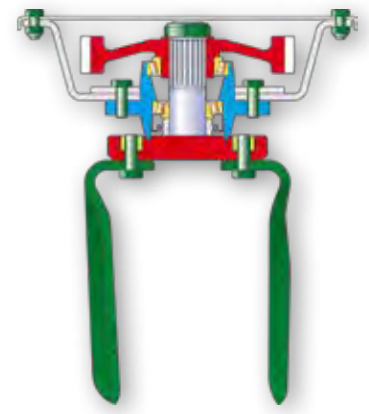

PERFECTION IN DETAIL

Mounting pieces hydraulically

Hydr. mounting piece with 2 cylinders
Available as option for mod.: Aress, Orbit



Stone protection bar

Available as option for mod.: Orbit



Depth adjustment

Model Aress, Orbit:
by means of a perforated grid and socket pin
A rigid guidance of the roller in the depth is possible by staking out from below.

Model KSE:
by means of spindle adjustment

Cam gear drive shaft front

Available as option for mod.: Orbit



Blades fast changing system

Available as option for mod.: Orbit



Track eradictors (optionally)

Standard version

- Adjustable in height through clamping plates
- Suitable for light soils with minimal stone portion

Non-Stop version

- Massive construction
- Adjustable through locking bolt
- Release force adjustable variably
- Suitable for all soil conditions



DIFFERENT ROLLERS FOR AN OPTIMAL SEEDBED PREPARATION.



Pipe flat bar roller

- ø450 mm
- Very light
- Good depth control
- Proof against stones

Not available for mod.: KSE



Packer roller

- Aress ø500 mm
- Orbit ø500 and ø550 mm
- Spacing in strokes 125 mm
- Leaves a fine crumbly seed bed
- High carrying power
- Low-lying scraper adjustable

Suitable for: light to heavy soils (universal)
stony soils

Ø 550 mm not available for Mod.: KSE



Crumbling packer roller

- Spacing in strokes 152 mm
- Deep solidification (due to the angled teeth)
- Leaves a crumbly surface structure
- Good load-bearing capacity

Suitable for: middle to heavy loamy soils
hillside locations



Ripple roller

- ø450 mm
- Spacing of strokes 125 mm (corrugated profile, adapted to the seeding line)
- Good solidification
- Leaves a fine crumbly earth in the area of seed deposition
- Good load-bearing capacity
- Blockage-free working (roller does not run on the inner tube)
- Self-propulsion through drive bars

Suitable for: middle to heavy soils
good for wet soils

Not available for Mod.: KSE



Seedstar RSM

With the seed drill RSM advantageous techniques and experiences were realized. With the compact mounting on the power harrow and the seed tank, which is moved to the front, the advantages in technique as weight distribution and low filling height were involved.

EXACT QUANTITY CONTROL IN COMBINATION WITH THE NEW COMBINED SLANTED CHAMBER.

LIGHT

PRECISE

FUNCTIONAL

USER-FRIENDLY



The stepless VARIO – gear

A 3-step-cam-lever system, which cares for highest precision at seeding. Seeding amounts from 1,5 – 300 kg can be put down steplessly and precisely on the fields.

- Variable adjustment of the seeding amount
- High precision by 3 cam levers
- Easily and comfortably adjustable



The gearbox Norton 80

A gearbox with 80 steps enables smooth and direct transmission to the seeding shaft. Also at lowest seeding amounts (f.e.: 800g/ha rape or 600g/ha poppy seed) the adjusted amount is not subject to fluctuations by the 100 per cent connection between the gear wheels. The gear lever of the gear is automatically locked after having adjusted the correct position.

- Total precision of the seeding amount through a 100 % connection.
- Low seeding amounts from app. 600g/ha (example poppy seed) possible
- High security through the automatic locking of the gear lever



The new combined slanted chamber

- Outputting of all sorts of seeds possible. (crop, grain legumes, green manure mixtures, grass-clover-leys, rape, phacelia, millet, clover, poppy seed,...)
- Closed chamber construction
- High precision
- Constant flow of seeds (perfect plant distribution)
- Perfect lateral distribution
- Easy decoupling of the slanted chamber for fine seeds

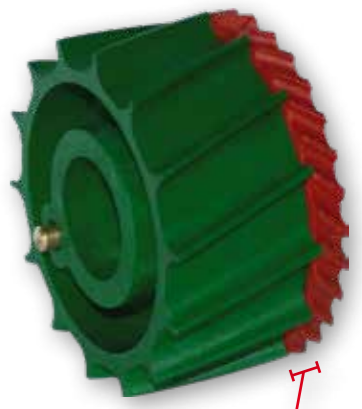

Fine drilling wheel

DOUBLE SEED PLATES WITH PRESSURE ROLLS FOR DEPTH CONTROL

Pressure rolls for depth control

- Perfect depth control
- Precise placement of the seed
- Immediate soil contact (speeded-up process of germination)
- Ideal for higher working speed
- Tool-free adjustment of the depth of the placement



Double seed plate

- Disc diameter $\varnothing 305$ mm
- Slim construction
- Displaced disc pairs
- Large passage
- Secure soil penetration
- No side draught
- Perfect suitable for mulch sowing system

Spring pressure adjustment

Optionally available



Cover front

Optionally available



Wiper backwards

Optionally available



Drift-share

- Suitable for the conventional cultivation
- Changeable abrasion wedge (cast iron wedge)
- No blocking through backwards mounted security-valve (rolling backwards on headland)



Central share pressure adjustment

- Infinitely adjustable by spindle
- Share pressure up to 35 kg for each seeding element

Hydraulic system optionally available



A precise seed deposition is the requirement for high yield.

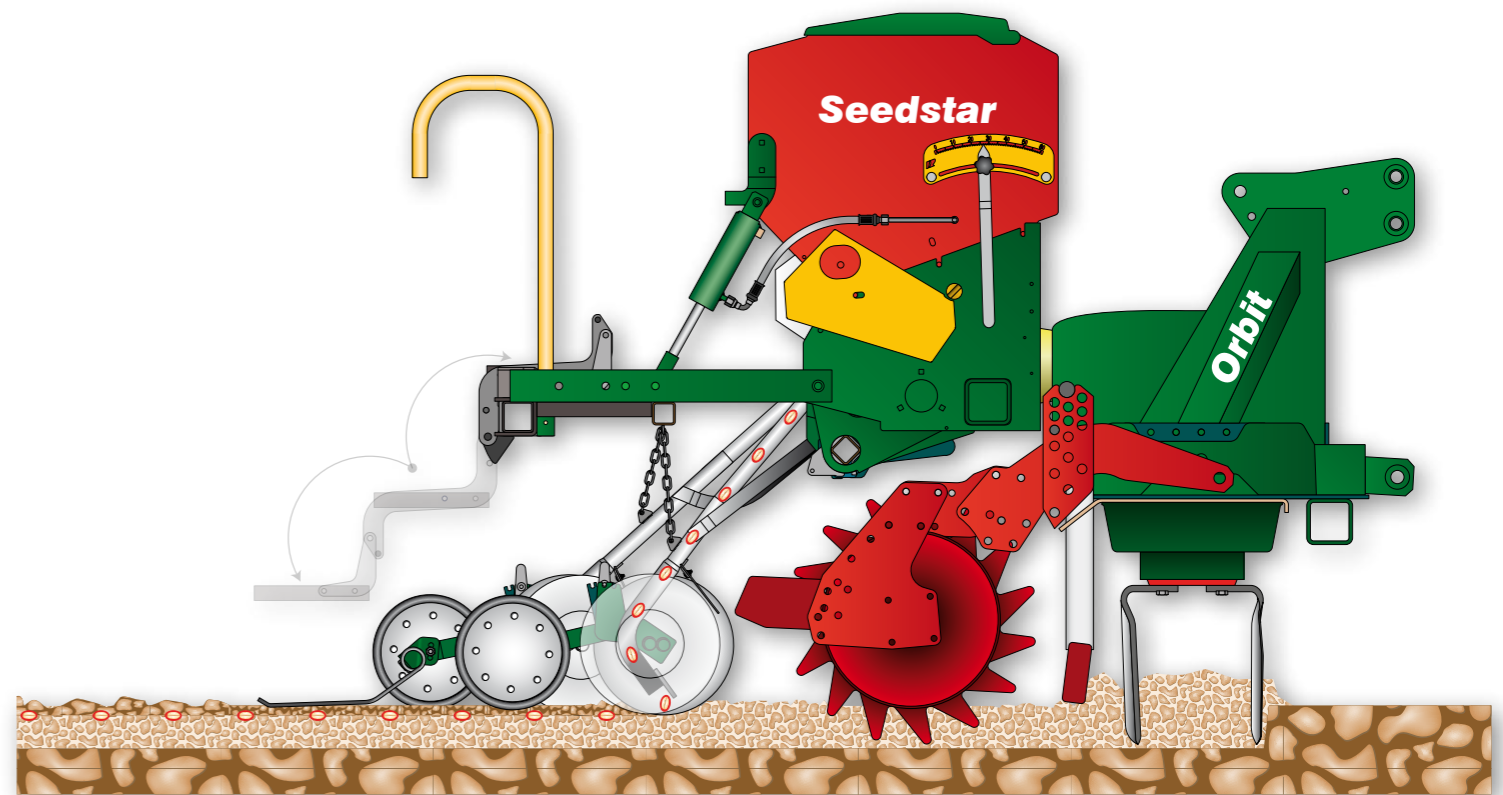

Single straw weeder

Tines are mounted directly on the pressure roll to enable simple smearing over of the seed rill.

- Compact and short construction
- Low weight
- Perfect suitable for light to middle soils



Seed weeder

The seed weeder is equipped with sprung double tines and 2 hinged stages.

- Adjustable easily and quickly
- Various possibilities of adjustments
- Folding upwards of the seed weeder possible
- Tool-free adjustable
- Perfect suitable for light to heavy soils

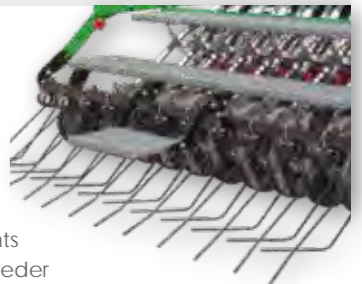

CONSTRUCTION VERSIONS

Semi-mounted

- Easy and quick mounting and dismounting of the drilling machine
- Tool-free fast coupling system with arrester hook
- Compact mounting
- Improved working of the power harrow on heavy loamy soils



Semi-mounted on the roller

- Good crumbling
- Higher solidification
- Increase of erosion protection
- Protection of the power harrow on stony soils (weight of the drilling machine transfers to the packer roller)
- Reduced abrasion of the tines of the power harrow

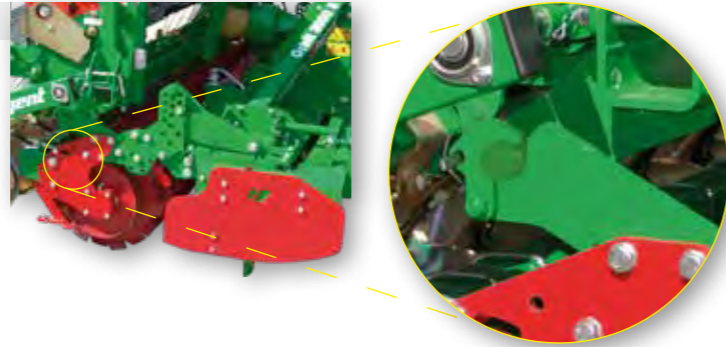

Wheel drive

- Use through hydraulic mounting parts
- Single use possible
- Big dimensioned wheels
- Full-featured drilling machine



Disc marker

The disc markers run hydraulically and can be folded vertically for transport. The width can be adjusted infinitely.



Pre-emergence marker

The pre-emergence marker runs hydraulically via Seedtron track appliance. The track width can be adjusted infinitely.

THE ANSWER IS IN DETAIL

The perfect solution with share automatic.

The unique share and star wheel automatic enable highest security and a perfect use of the machine in the edge of the field. After the starting first the power harrow is used not fill then the seed shares and the star wheel of the Seedstar follow.

- High security against damages during turning on headland.
- High security against blockages due to crop residues on headland.
- Single use without decoupling the drilling machine or without having to get off the tractor.
- No heavy load pivot point

Serially with hydraulic share and star wheel automatic



The seed tank

- High stability due to complete manufacturing in metal
- Low filling height of appr. 1,5 m
- Dividing walls made of metal
- Keys between the outlets made of metal
- Filling by farm or front loader possible
- Agitator shaft as standard (may be switched off)
- Mechanic hopper level indication
- Expandable through hopper extension

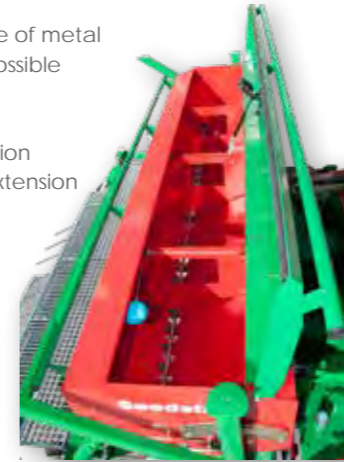

Spike wheel drive

The big dimensioned spike wheel with pre-load to the ground, cares for constant drive and avoids slippage.

The monitor "Seedtron S2"

The monitor is equipped with a magnet in the back and therefore can be mounted in sight in the tractor cabin.

Through the Seedtron monitor following functions can be triggered or controlled.



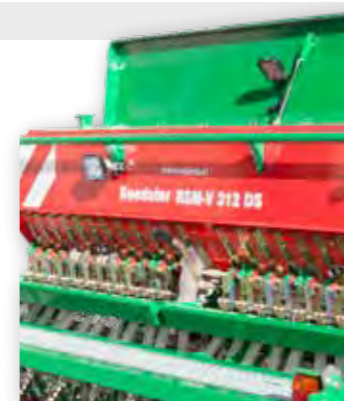

- Machine track gear shift with optional adjustable rhythms.
- HA-numerator with planimetry functions of the single acreage and total acreage.
- Speed control of the seeding shaft
- Filling level indicator
- Working speed indicator
- Calibration trial with "stop" signal
- LED working lights
- Integrated seeding scale
- guided machine adjustment adapted to the respective fruit variety
- Performance control ha/h
- Display and keyboard illumination

LED working lights

- Optionally available in connection with the monitor Seedtron S2
- Tank and work lights



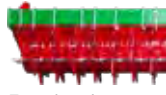

Type	Working width	Length of knife tines	kW	HP	Rotors			RSW 				ZPW 		KPW 		WPW 
								Cage roller	Toothed packer roller	Crumbling packer roller	Waved packer roller					
Aress		cm	mm			U/min	kg	ø450	ø460	ø500	ø550	ø500	ø450			
2500	250	300	95	130	10	250/311/352	770	880		1065		1070				
3000	300	300	95	130	12	250/311/352	830	1000		1180		1190	1230			
Orbit																
2500 M	250	300	125	170	10	212/.../477	970	1080	1230	1265		1270				
3000 M	300	300	125	170	12	212/.../477	1040	1210		1390	1430	1400	1440			
3000 S	300	330	180	250	12	283/341	1100			1450	1490	1460	1500			
KSE HK																
5000 HK	500	300	220	300	20	312/399				2680		2710				
5000 M-HK	500	300	220	300	20	312/399				2985		3015				
6000 M-HK	600	300	220	300	24	312/399				3305		3335				

Seedstar	Working width cm	Drift-share	Double shares	Gearbox	Amount of lines	Distance of lines cm	Hopper capacity liter	Transport width cm	Weight kg
RSM-V 252	250	✓		Vario	20	12,5	570	250	535
RSM-V 252 DS	250		✓	Vario	20	12,5	570	250	655
RSM-V 312 DS	300		✓	Vario	24	12,5	700 / 1050	300	745 / 815
RSM-G 312 DS	300		✓	80 steps	24	12,5	700 / 1050	300	755 / 825

Subject to technical changes and misprints.

Regent Pflugfabrik GmbH
Bahnhofstr. 105
4800 Attnang-Puchheim
Austria



Tel. +43 7674 62661
Fax. +43 7674 62207
info@regent.at
www.regent.at

